



P6 Outdoor Full-color LED Display

(320×160)



Catalogue

Chapter 1 Product Introduction	1
Chapter 2 Appearance Structure	2
2.1 Appearance Picture.....	2
2.2 Technical Parameter	2
2.3 Packing List.....	3
2.4 Power Supply Configuration Project.....	3
2.5 Accessories	3
Chapter 3 Interface Definition	4
Chapter 4 Installation	5
4.1 Kit Installation.....	5
4.2 Display Installation	6
4.2.1 Diagram for Cable Connection	6
4.2.2 Networking Introduction	7
4.2.3 Installation Method.....	8
Chapter 5 User Manual.....	9
Chapter 6 Acceptance Request and Method	10

Chapter 1 Product Introduction

- **High refresh、 High gray scale**

The refresh rate can reach more than 3840Hz, the gray scale is 12-14 bit, the display picture is fine and true, the brightness is stable and uniform, there is no flicker and graininess.

- **Driving solutions**

Exploits precise current regulation technology, with both channel-to-channel error and chip-to-chip error less than $\pm 2.0\%$.

Enhancement: Non-uniformity at low gray scale, Color shift, low gray mosaics.

Elimination high contrast coupling an color-cast between modules.

- **High viewing angle and high contrast**

It is to adopt red, green and blue SMD2727 LED chips, nice conformity, contrast ratio can be up to 5000:1, visual angle can be up to above 120° , high reliability, long lifespan.

Chapter 2 Appearance Structure

2.1 Appearance Picture

Picture 2-1 Appearance Picture

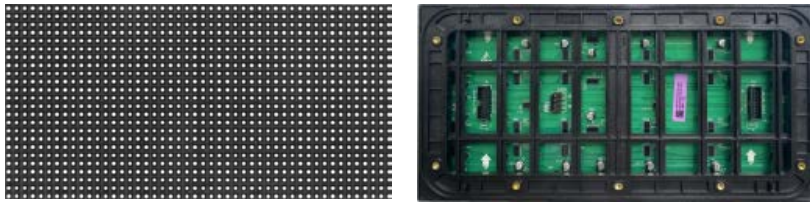

2.2 Technical Parameter

Table 2-2 Technical Parameter

Item	Technical parameter	
Unit module	Product Mode	IFS-EOA6S-C
	Module size	320mm(W)*160mm(H)
	Pixel pitch	6.67mm
	Pixel Density	22500dots/m ²
	LED specification	2727 SMD
	Pixel resolution	48dots(W)*24dots(H)
	Weight	0.48kg±0.02 kg
optical parameter	Best viewing distance	≥6m
	viewing angle	120±10°(H)/120±10°(V)
	Pixel configuration	1R1G1B
	Brightness of while balance	≥4000cd/m ²
Electrical parameter	Working voltage	5V
	Max Power consumption	≤40W
	Driving device	Constant Current driver
	Drive type	1/6 Scanning
	Refresh frequency	≥3840Hz
Main technical parameter	operating environment	Outdoor
	Working temperature	-20℃~60℃
	Operation humidity	10%~60%

*We would not provide additional notification if the product information has any update, our company do not take any obligation because of this.

2.3 Packing List

Table 2-3 Packing List

Packing List	Qty	Unit
LED Display	1	set
User Manual	0	pcs
Approved Certificate	0	pcs
Warranty Card	0	pcs
Construction Notification	0	pcs



2.4 Power Supply Configuration Project

Table 2-4 Power Supply Configuration solution

Power Supply	Configuration Project
40A Power Supply	Can load 4pcs modules
60A Power Supply	Can load 6pcs modules

2.5 Accessories

Table2-5 Accessories List

Accessories	Name	Picture
Module magnetic suction accessories	Rubber ring	
	Power cable (General specifications: 2.0 square for main line and 0.628 square for branch line)	
	Flat cable (conventional 16p 200mm between modules)	

Chapter 3 Interface Definition

Picture3-1 Interface Picture (HUB75)

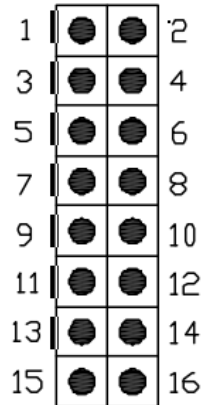

Table 3-2 Interface Definition

Pin	Signal	Function	Pin	Signal	Function
1	R1	Red Data Signal	2	G1	Green Data Signal
3	B1	Blue Data Signal	4	GND	Power Ground
5	R2	Red Data Signal	6	G2	Green Data Signal
7	B2	Blue Data Signal	8	GND	Power Ground
9	A	Row Decoding Signal	10	B	Row Decoding Signal
11	C	Row Decoding Signal	12	D	Row Decoding Signal
13	CLK	Clock Signal	14	LAT	Latch Signal
15	OE	Enable Signal	16	GND	Power Ground

Chapter 4 Installation

4.1 Kit Installation

Picture 4-1 Hole Installation Diagram for Kit

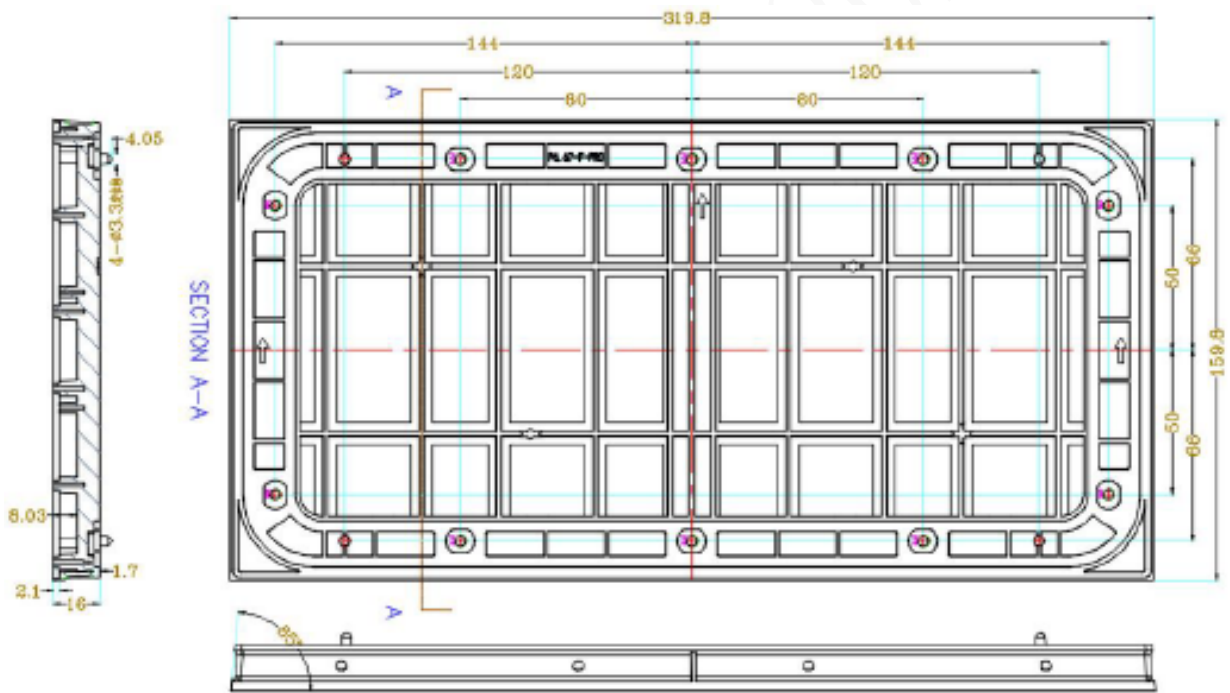

Unit: mm

4.2 Display Installation

4.2.1 Diagram for Cable Connection

Picture 4-3-1 Diagram for Connection

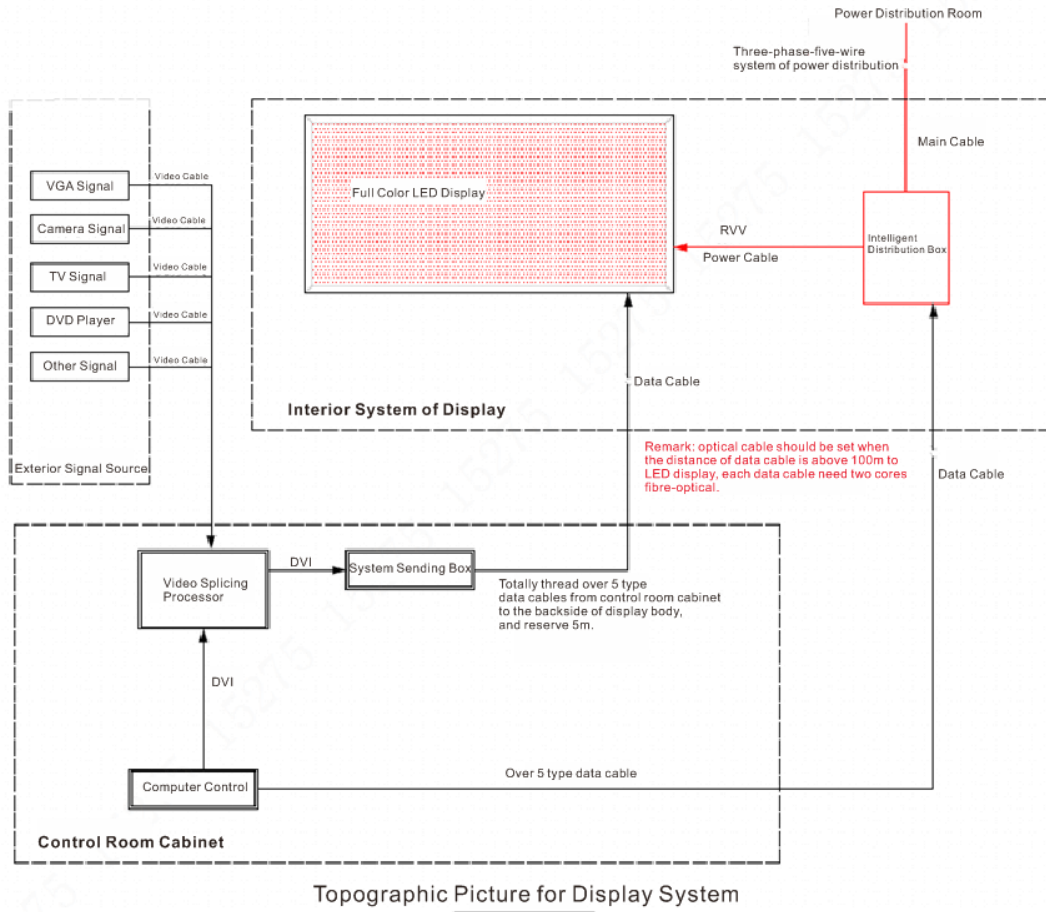

4.2.2 Networking Introduction

Picture 4-3-2 Topographic Picture for networking

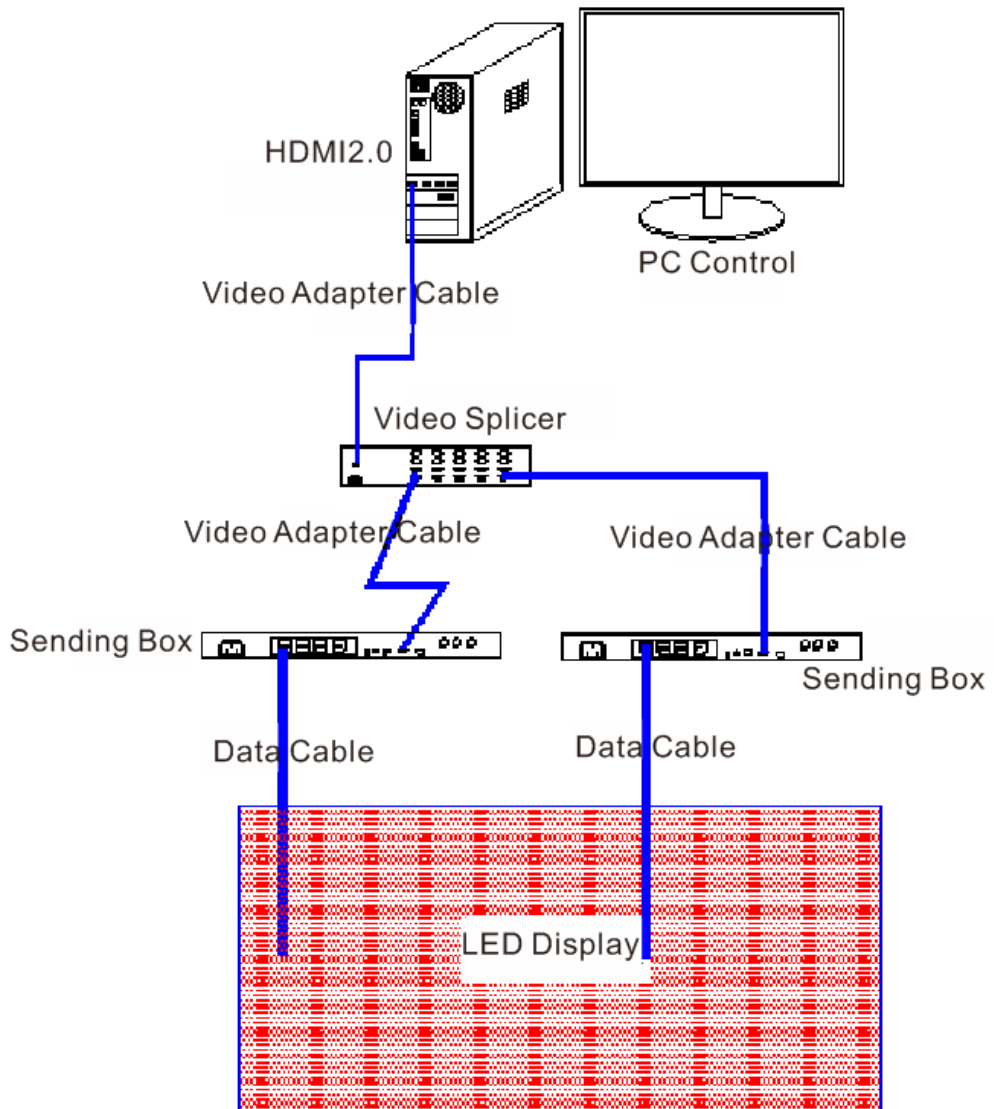

4.2.3 Installation Method

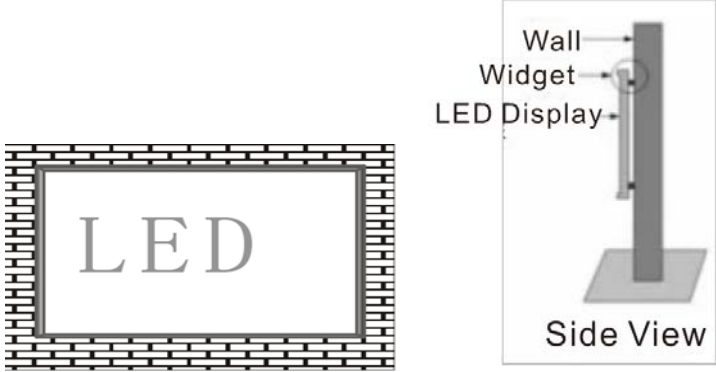
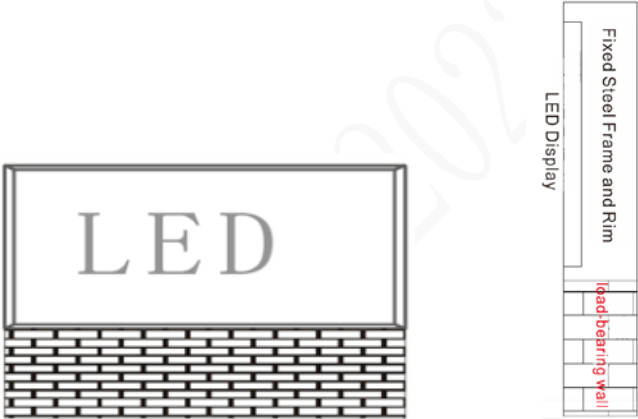
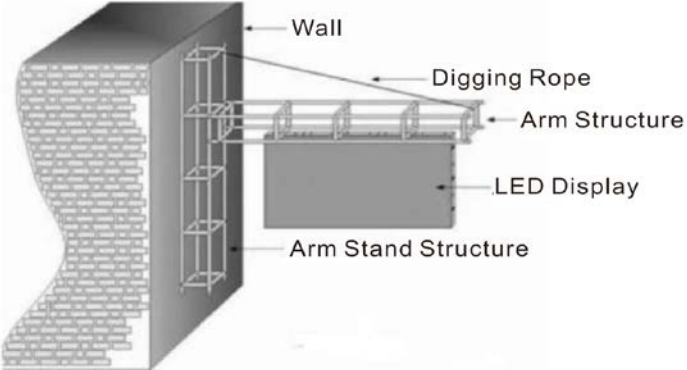
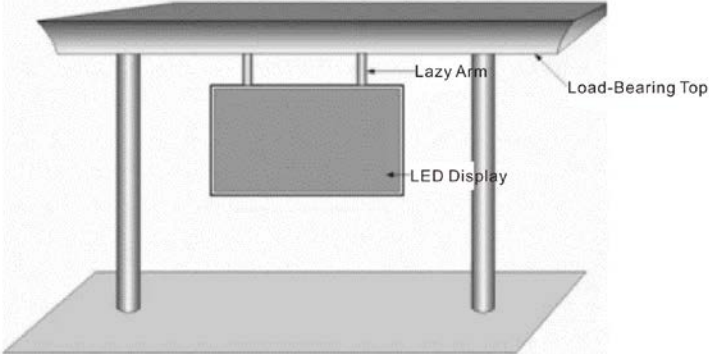
Installation Type	Picture
<p>Wall Mounted Installation</p>	
<p>Floor Mounted Installation</p>	
<p>Cantilever Type Installation</p>	
<p>Hanging Type Installation</p>	

Chapter 5 User Manual

Table 5-1 Notification

Item	Notification
Temperature	Keep the work temperature within -10°C~60°C
	Keep the storage temperature within -10°C~60°C
Humidity	Keep the work humidity within 10%RH~60%RH
	Keep the storage humidity within 10%RH~60%RH
Waterproof	Module: IPX5 Front
Dust-proof	Module: IP6X Front
Anti-Electromagnetic radiation	LED display shouldn't put under the environment where has strong interference by electromagnetic radiation, which would be easy to picture display abnormal.
Electrostatic Prevention	It should be ground connected well for power supply, cabinet, mental cover of display body, the resistance of ground connection<10Ω, to avoid making any damage to electric components.

Item	User Manual
Electrostatic Protection	The installer need wear electrostatic ring and electric gloves, each equipment should take ground connection well when installing.
Connection Type	There are positive and negative electrode silk printed on module, don't allow to reverse connect, and prohibit to connect with AC 220V.
Operate Type	Prohibit to assemble module, cabinet and whole of display under power on, operation should be under power off completely, to protect personal safety; Prohibit anyone to touch when the LED display is working, in case the static electricity which is generated by body to break through LED and other components.
Dismantle and Transportation	Don't allow to throw, push, compress module, to prevent module falling down, to avoid breaking kit, damage LED chips, etc.
Environmental Inspection	It should match temperature and humidity meter for LED display at installation site, to monitor its surrounding environment, so that it can find out if LED display being affected with damp, moisture, etc.
The Usage of LED display	The environmental humidity should be 10%RH~90%RH, it is suggested to turn on LED display one time each day, normal to use above 4 hours each time, to remove its damp.
	When the environmental humidity is above 90%RH, it should make dehumidification to environment, and it is suggested to work LED display above 8h each day.
	When LED display has not turned on for a long time, it should preheat LED display to remove moisture before use, to avoid damage LED because of damp, the specific method: 20% brightness to work for 2h, 40% brightness to work for 2h, 60% brightness to work for 2h, 80% brightness to work for 2h, 100% brightness to work for 2h, by this to gradually increase its brightness.

Chapter 6 Acceptance Request and Method

Table 6-1 Acceptance Request and Method for LED display

Item	Acceptance Request and Method
Brightness of LED Display	Switch LED display to work as full brightness, use light-gun to measure the brightness of LED display within 10 minutes. When measuring its brightness, the light-gun need be vertical to LED display, to adjust the distance of light-gun and LED display, ensure the view window, black area, cover above 16 pixels, adjust focal length, to ensure LED chip being able to clearly view in eyepiece, then measure and record brightness data.
Visual Angle	The one should stand on the angle of 120° , bottom angle 65° to LED display when making measurement, it is requested that LED display should not have obvious the problem of dark block.
<p>The diagram consists of two parts. The left part shows a horizontal rectangle labeled 'LED Display'. A horizontal line passes through the center of the rectangle. Below the rectangle, two lines labeled 'Sight Line' originate from a single point and extend upwards to the bottom corners of the rectangle. An arc between these two lines is labeled 120°. The right part shows a vertical rectangle labeled 'LED Display'. A horizontal line extends from the top-right corner of the rectangle to the right. A line labeled 'Sight Line' originates from the same top-right corner and extends downwards and to the left. An arc between the horizontal line and the sight line is labeled 65°.</p>	